

A Cutting-Edge Digital Microscopy Camera Equipped with Dual CCD Sensors,
Providing Both High Sensitivity Monochrome and High-Quality Single-Shot Color Images.

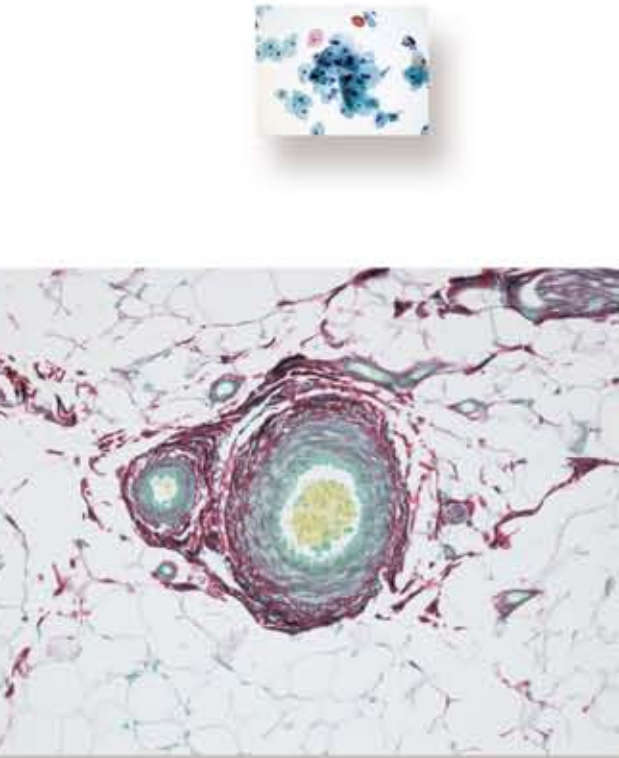

A Simple Switching Operation Allows the Sensor on the



Superior Bright-Field Images
at High Resolution

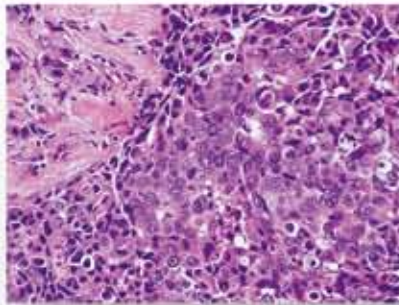
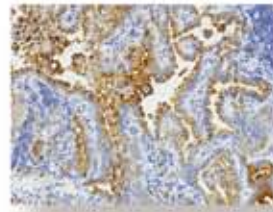

Consider how convenient and easy it would be if both high resolution bright-field and high-sensitivity fluorescence images could be observed and acquired using a single microscope camera. The DP80 digital camera answers this simple yet important need to have two cameras in one.

Since it is possible to rapidly switch between the monochrome CCD sensor and color CCD sensor, it is possible to easily acquire high-quality bright-field and high-sensitivity fluorescence images of the same field. Without the need to switch camera ports with a prism, the time required to align the camera sensors is eliminated.

The DP80 assists you in your research activities from observation to documentation in a smooth and easy manner.

Use of Either a Color or Monochrome CCD

Same Camera Unit.

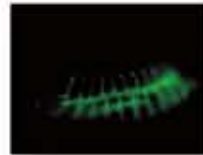

Clear Fluorescence Images
with Excellent Sensitivity

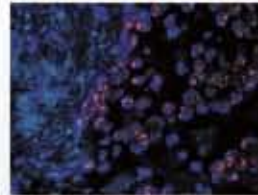
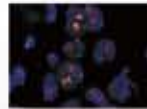
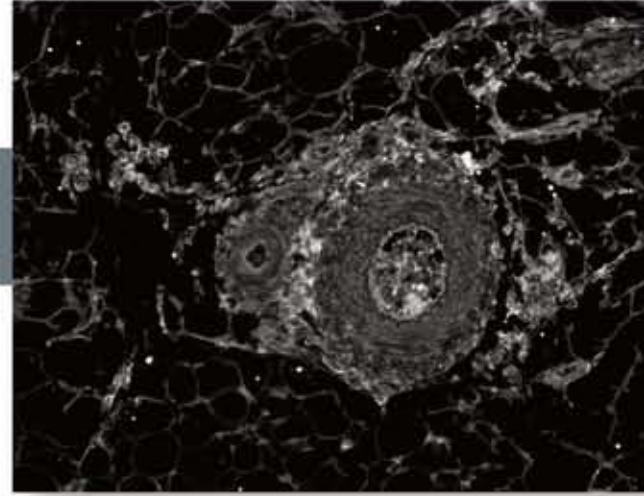
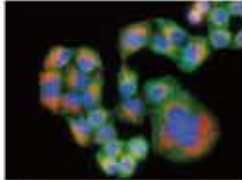

High Quality Images Adapted to Observation and Imaging Methods Can Be Readily Obtained.

A Monochrome Camera that Detects and Captures Dim Fluorescence Images

Clearly Observe Weak Fluorescence Signals with the DP80's High Sensitivity

We significantly improved the DP80's fluorescence imaging performance by incorporating a separate high dynamic range monochrome CCD sensor within the body of the camera. Combined with thermo-electric cooling and high resolution capture, the DP80 meets the demands for low-light fluorescence imaging. With a high quantum efficiency along a wide spectrum, the DP80 provides exceptional fluorescence signal detection.

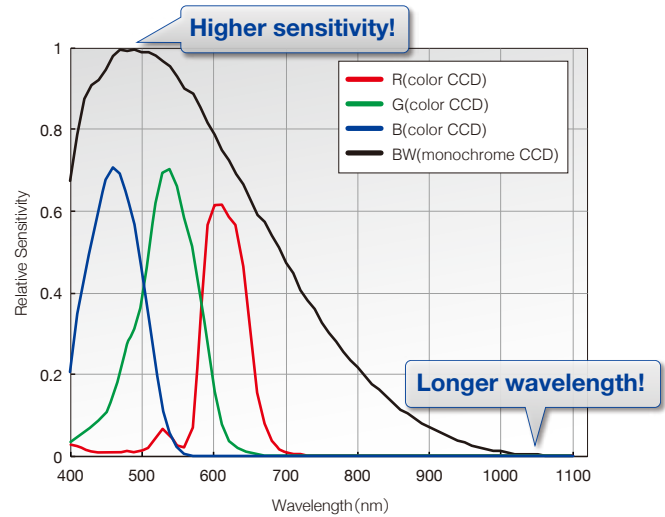
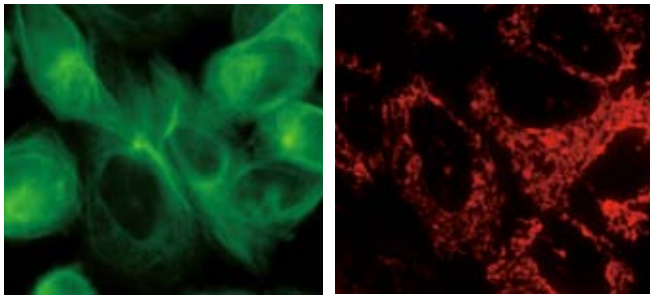

High-Sensitivity Fluorescence Imaging Available Up to Cy7 Wavelengths

The DP80 responds to a wide range of wavelengths from visible to near infrared. Now sensitive to fluorescence signals with longer wavelengths, the DP80 captures near-IR wavelengths from samples stained with Cy7 (767 nm).

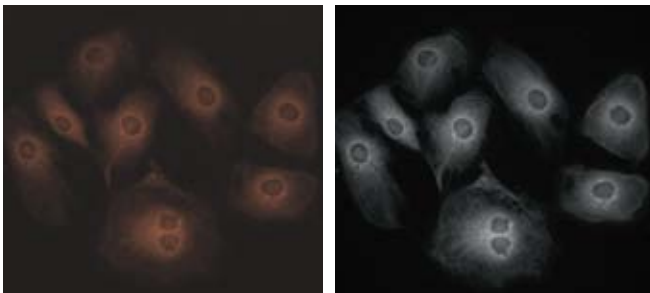

Color image (exposure time: 60 s)

Monochrome image (exposure time: 2 s)

Color and Monochrome Images Can Be Overlaid with Pixel Precision

By using the multiple image centering function which allows minimizing pixel shifts among images, it is possible for a user to precisely superimpose color and monochrome images that are acquired by different observation methods.

For instance, this function is very suitable to define the morphology and the localization between bright-field and fluorescence images.

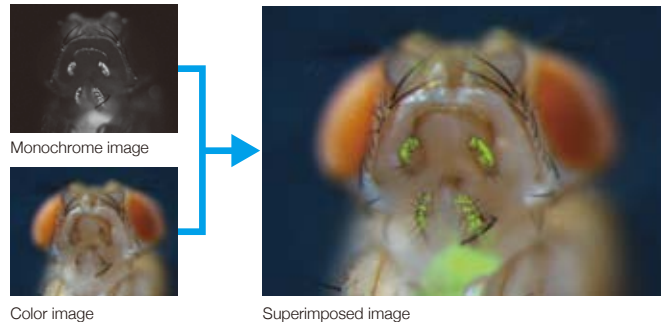

Research Workflow Is Improved Through Olympus CellSens* Imaging Software

Efficient Support of Observation and Experimentation

High-quality color and multi-channel imaging is automated with the DP80's switchable CCD sensors and the intuitive Olympus cellSens* software interface. From complex image acquisition to image processing to report generation, the researcher can focus on research activities instead of routine labor-intensive acquisition setup and data preparation.



*cellSens software is not for clinical diagnostic use.

Color Camera Provides Clear Real-Time Live Preview Display

High Definition Uncompressed Live Images of 1360x1024 Pixels

Live view display of high definition RGB 24-bit color images of 1360 x 1024 pixels at 15 frames per second. Distortion-free focusing or framing is provided because there is no deterioration of image quality due to compression and so sample details are sharp and clear whether the sample is stationary or moving.

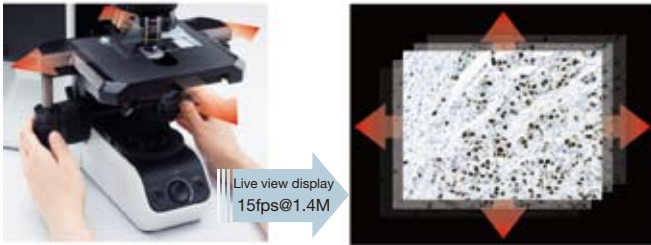

High Resolution Imaging Up to 12.5 Megapixels

The DP80 uses pixel-shifting technology to reach a maximum recording image size of 4080 x 3072, a high resolution equivalent to 12.5 megapixels.

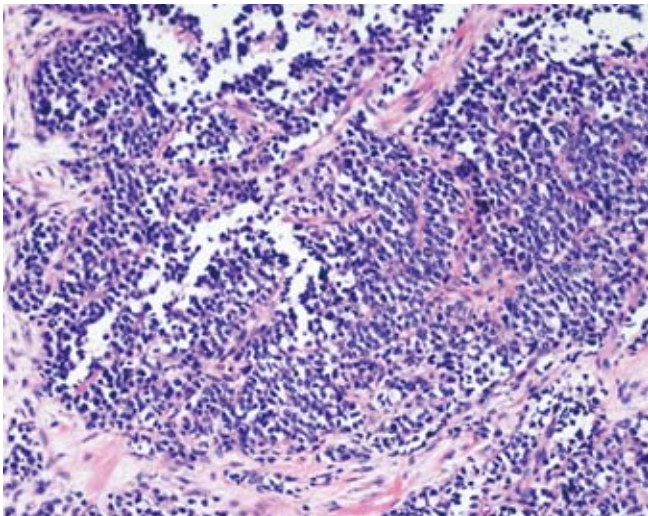

Fine-Detail Processing that Suppresses Pseudo-Colors and Moiré Artifacts

The DP80 is equipped with Fine Detail Processing, which reduces pseudo-colors and moiré patterns of structures and improves resolving power. Clear imaging of details is achieved by fully extracting the resolving power of objective lenses.

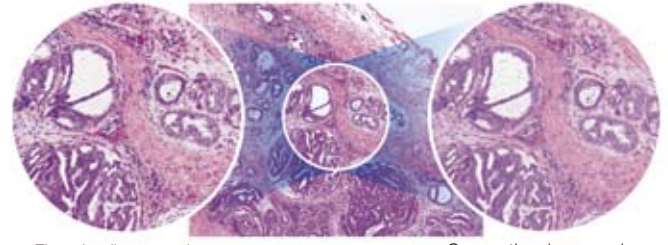

Fine-detail processing

Conventional processing

Superior Color Reproducibility Captures Fine Differences in Color

Subtle hue differences within colors such as brown, blue, and purple were difficult to distinguish in the past, but now, such slight differences in color can be reproduced by incorporating AdobeRGB* color space which reproduces a wide range of color tones and a new algorithm of color reproduction. Color images faithful to the original samples can be acquired.

*Color reproduction fidelity depends on monitor specifications. Monitors supporting AdobeRGB are required to accurately reproduce images recorded in AdobeRGB mode.

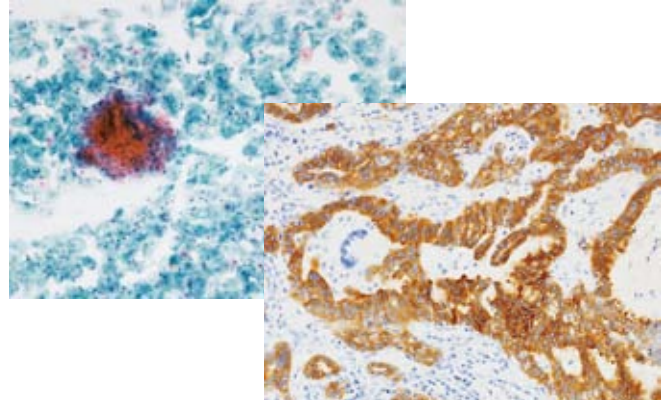

Faithful Panoramic Imaging, with High-Quality in Bright-Field or Fluorescence

Multiple-region capture of saved images can be easily recombined and restitched seamlessly into a single image. Numerous annotations and comments can be saved with images for later retrieval. These features are useful for standardization and accuracy control of inspection and research processes.

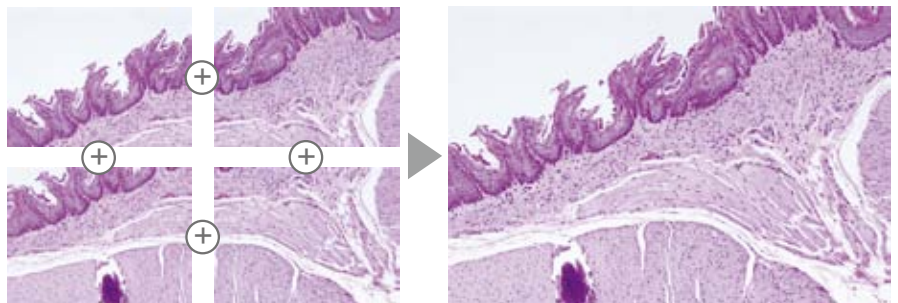

High Quality Bright-Field and High-Sensitivity Multi-Channel Fluorescence The DP80 Alone Can Provide All of the Images That Are Illustrated Below

Captured by color CCD

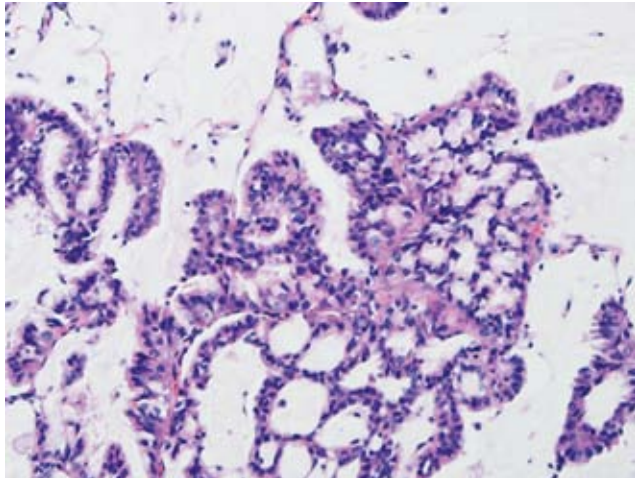

Fig. 1: Histology of lung with EML4-ALK fusion gene. (HE stain).

Captured by monochrome CCD with pseudo-colors

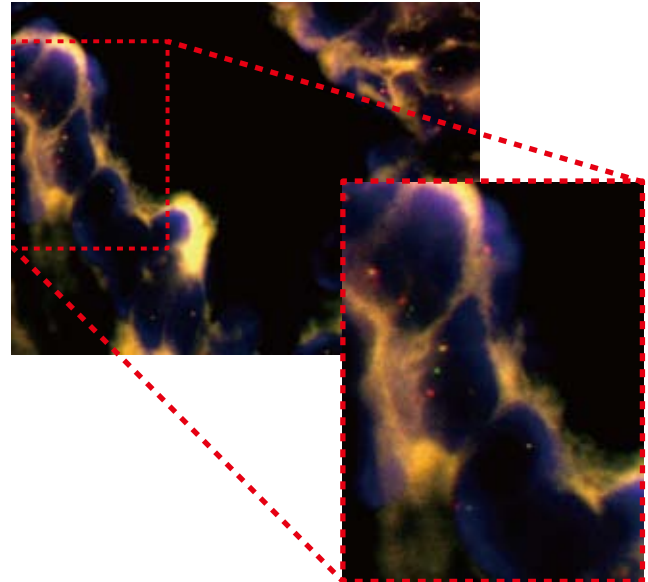

Fig. 2: Same case as Figure 1. FISH was performed using ALK Split Dual color FISH probe (green = FITC and red = TexRed) (GSP Laboratory). The abnormal ALK split signal was observed as green and red colored signal, in addition to normal yellow-colored signal.

Captured by color CCD

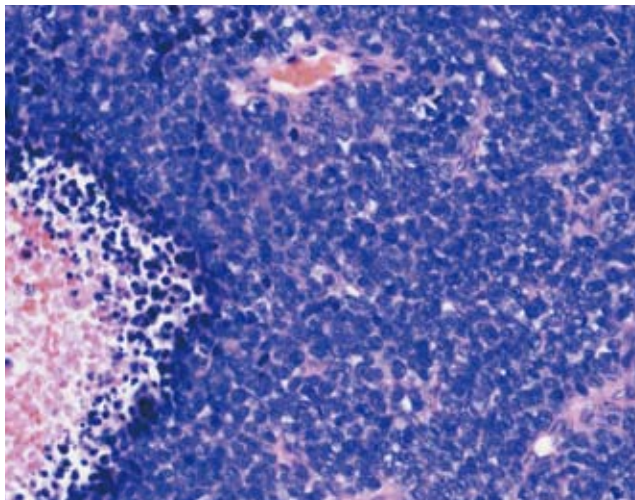

Fig. 3: Histology showing small round cell with many mitoses and nuclear atypia. (HE stain)

Captured by monochrome CCD with pseudo-colors

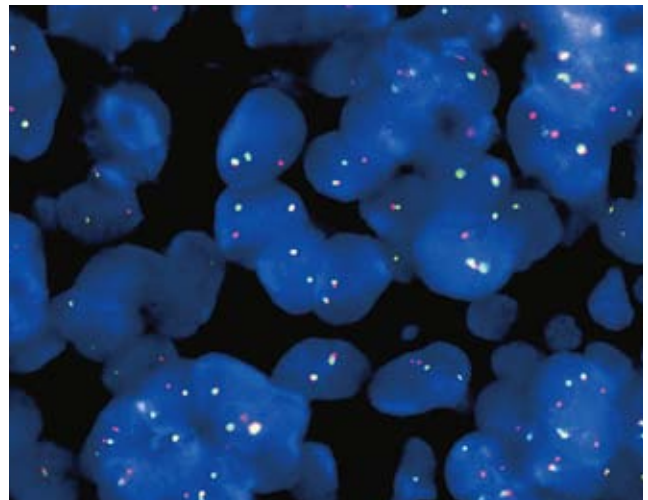

Fig. 4: Same case as Figure 3. FISH was performed using EWSR1 (22q12) dual color break apart rearrangement FISH probe (green = spectrum green and orange = spectrum orange) (Vysis, Abbott Japan). The abnormal EWSR1 split signal was observed as green and orange colored signal, in addition to normal yellow-colored signal.

Image data courtesy of : JAPANESE FOUNDATION FOR CANCER RESEARCH The Cancer Institute, Division of Pathology Noriko Motoi, M.D., Ph.D. Yuichi Ishikawa, M.D., Ph.D.

nce Imaging ow.

Captured by color CCD



Surface of *Drosophila melanogaster* expressing fluorescence protein in peripheral sensory cells.
Image data courtesy of : Institute of Molecular and Cellular Biosciences, University of Tokyo Kei Ito, Ph.D.

Captured by monochrome CCD



Captured by color CCD

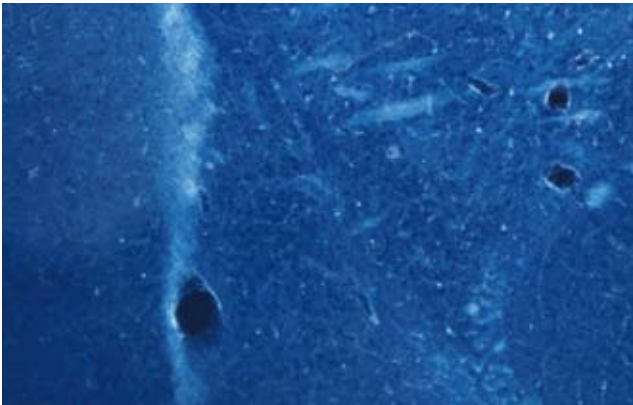

In the dark field images we can see the borders of the lateral amygdala, a brain region important for fearful emotions. In the fluorescence image are cells and processes expressing a fusion protein of channelrhodopsin/EYFP. Channelrhodopsin is a blue light activated non specific cation channel that is used in 'optogenetics' experiments. We can express channelrhodopsin in lateral amygdala neurons and produce emotional fear memories by activating the cells with blue light. These microscope images allow us to verify that expression of channelrhodopsin has occurred in the lateral amygdala.
Image data courtesy of : RIKEN BRAIN SCIENCE INSTITUTE Neural Circuitry of Memory Joshua P. Johansen, Ph.D.

Captured by monochrome CCD with pseudo-colors

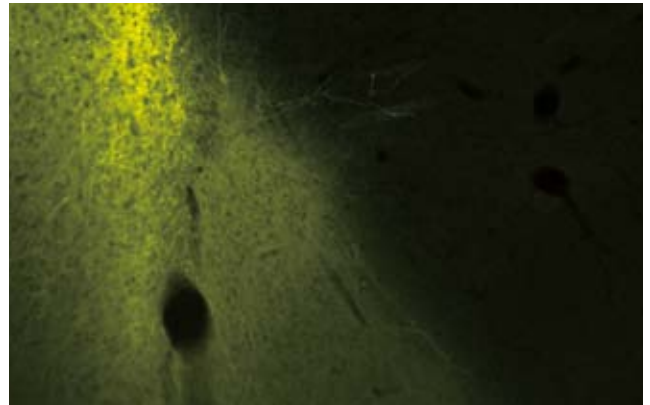

Captured by color CCD

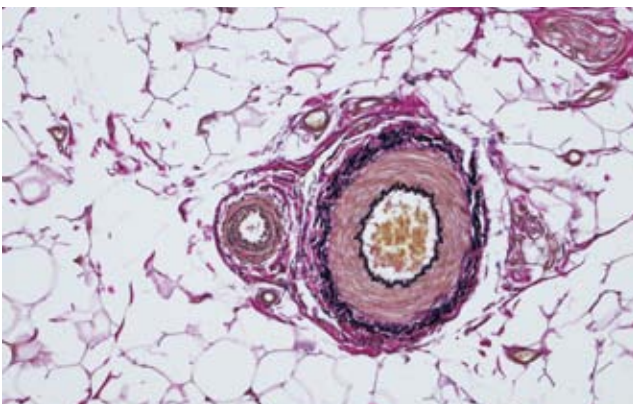

Observation of Collagen type I and type III with multicolor immuno-fluorescence staining during wound healing process
Bright-field image of total collagen with Elastica van Gieson (EVG) staining (Left; DP80 color mode) and, multi-fluorescent pseudo-color image of collagen type I labeled with Cy7 and collagen type III labeled with Cy5 respectively (Right; DP80 monochrome mode). Location of the collagen type I and III is confirmed clearly by the long-wavelength observation without auto-fluorescence noise such as erythrocytes and/or other tissue components.

Captured by monochrome CCD with pseudo-colors

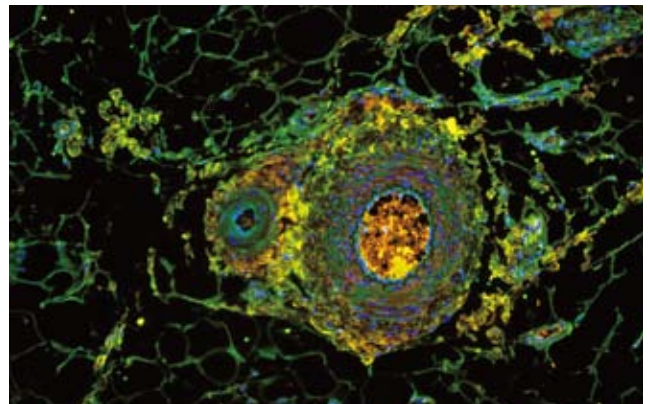

DP80 specifications

Item	Specifications		
Camera type	Color / Monochrome 2CCD camera Pixel shifting (only for color CCD) Cooling system: Peltier device (max. Ta -10 degreeC)		
Image sensor	Size	[Color] 2/3 inch 1.45 mega pixels color CCD, RGB colors on chip filter (Bayer) [Monochrome] 2/3 inch 1.45 mega pixels monochrome CCD	
	Scanning mode	Progressive scan	
Camera mount	B4 mount (2/3 inch Bayonet mount)		
Exposure control	Mode	Auto, SFL-Auto, Manual	
	Adjustment	±2.0 EV step: 1/3 EV	
	Exposure time	23 µs to 60 s	
Metering modes	Full image, 30%, 1%, 0.1%		
Binning	2x2, 4x4		
Live frame rate	1360 x 1024 (1x1): 15 fps, 680 x 512 (1x1) : 15 fps 680 x 510 (2x2): 29 fps, 340 x 250 (4x4) : 57 fps		
Color	Image Resolution	[Centering OFF] 4080 x 3072 (Pixel shift) 2040 x 1536 (Pixel shift) 1360 x 1024 (1x1), 680 x 512 (1x1) 680 x 510 (2x2), 340 x 250 (4x4)	[Centering ON]** 3648 x 2736 (Pixel shift) 1824 x 1368 (Pixel shift) 1216 x 912 (1x1), 608 x 456 (1x1) 608 x 456 (2x2), 304 x 228 (4x4)
		ISO Sensitivity	ISO200/400/800/1600 equivalent
	A/D	14 bit *Number of effective bit: 12 bits@16 bit mode image	
	Image acquisition time *	4080 x 3072: approx. 3.3 s, 1360 x 1024: approx. 0.3 s	
	Color space	sRGB, AdobeRGB (only for color CCD)	
	Monochrome	Image Resolution	[Centering OFF] 1360 x 1024 (1x1), 680 x 512 (1x1) 680 x 510 (2x2), 340 x 250 (4x4)
Gain			x0.5/x1/x2/x4/x8/x16
A/D		14 bit *Number of effective bit: 14 bits@16 bit mode image	
Full well capacity		17000e- (Gain 0.5x)	
Readout noise		7e-	
Dynamic range		2300:1 (Gain 0.5x)	
Quantum efficiency		55% (500 nm)	
Dark current		0.4e-/pixel/s (Ta=25degere C)	
Image acquisition speed *		1360 x 1024: approx. 7.7fps, 680 x 510 (2 x 2): approx. 14.3fps, 340 x 250 (4 x 4): approx. 20fps	
Image file format		File formats supported by cellSens software	
Dimensions, weight	Camera head	133 mm(W) x 130 mm(D) x 139 mm(H) /approx. 2.5 kg	
	Interface cable	Approx. 2.8 m/approx. 0.23 kg	
	External trigger cable	Approx. 0.2 m/approx. 40 g	

* Image acquisition time and speed may be reduced if exposure time increases or several tasks are active in the background.
** "Centering" is a camera function which aligns the positions of the color and monochrome CCD sensors.

DP80 system requirement

	PC/AT compatible
CPU	Intel Core i5/ Intel Core i7 / Intel Xeon
RAM	4 GB or more (8 GB recommended for high speed image acquisition)
HDD	Free space of 1 GB or larger (at the time of installation)
Graphics	1280x1024 (min. 1024 x768) monitor resolution with 32 bit video card with separate graphics memory (no integrated graphics processor with shared memory)
Extension slot	PCI-Express x1 Rev. 1.0a or later Compatible with half size or LowProfile PCIe board (106.7 mm x 174.6 mm)
OS	Windows 8.1 Pro (64 bit) Windows 8 Pro (64 bit) Windows 7 Professional/Ultimate with SP1 (64 bit)
Power supply	250 W or more Unoccupied FDD power cable, HDD power cable (4-pin size), or Serial ATA power cable must be available

* Please use computers that conform to the regulations for your region.

DP80 System Diagram

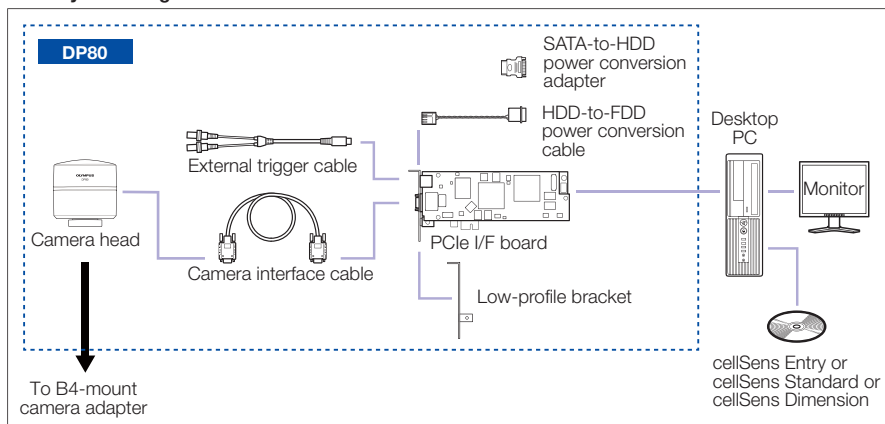

DP80 Camera Head Dimension

(Unit: mm)

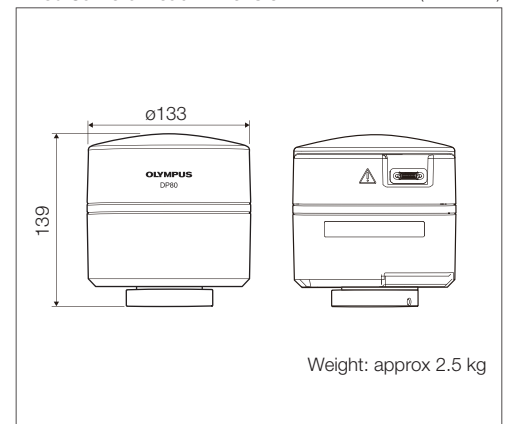

- OLYMPUS CORPORATION is ISO14001 certified.
- OLYMPUS CORPORATION is FM553994/ISO9001 certified.
- All company and product names are registered trademarks and/or trademarks of their respective owners.
- Images on the PC monitors are simulated.
- Specifications and appearances are subject to change without any notice or obligation on the part of the manufacturer.

www.olympus-lifescience.com

OLYMPUS

For enquiries - contact
www.olympus-lifescience.com/contact-us

OLYMPUS CORPORATION
Shinjuku Monolith, 2-3-1 Nishi-Shinjuku, Shinjuku-ku, Tokyo 163-0914, Japan
OLYMPUS EUROPA SE & CO. KG
Wendenstrasse 14-18, 20097 Hamburg, Germany
OLYMPUS SCIENTIFIC SOLUTIONS AMERICAS CORP.
48 Woerd Avenue, Waltham, MA 02453, U.S.A.
OLYMPUS SINGAPORE PTE LTD.
491B River Valley Road, #12-01/04 Valley Point Office Tower, Singapore 248373
OLYMPUS AUSTRALIA PTY. LTD.
3 Acacia Place, Notting Hill VIC 3168, Australia

OLYMPUS LATIN AMERICA, INC.
5301 Blue Lagoon Drive, Suite 290 Miami, FL 33126, U.S.A.
OLYMPUS (CHINA) CO., LTD.
A8F, Ping An International Financial Center, No. 1-3, Xinyuan South Road,
Chaoyang District, Beijing, 100027 P.R.C.
OLYMPUS KOREA CO., LTD.
8F Olympus Tower, 446 Bongeunsa-ro, Gangnam-gu, Seoul, 135-509 Korea